

ASP

MENSAN



**МОДЕЛЬНЫЙ РЯД
ТОРМОЗНЫХ ДИСКОВ**

ASP
MENSAN





ASP MENSAN

www.aspmensan.ru



Завод «Mensan Otomotiv A.S.» – крупнейшее предприятие в Турции, с конвейера которого сходят детали тормозной системы для легковых, коммерческих и грузовых автомобилей, изготовленные методом литья. Завод, расположенный в Манисе, в западной части Турции, был построен в 2002 г. Его производственные корпуса занимают площадь около 17 500 кв.м.

Сегодня это одно из немногих турецких предприятий полного цикла, включающее литейное производство. Ежегодная производительность завода – 36 000 тонн чугуна и 18 000 тонн готовой продукции.

К преимуществам дисков «ASP MENSAN» относятся:

- Завод полного производственного цикла;
- Контроль качества металла в процессе литья (собственное литейное производство);
- Поставка на сборочные конвейеры AXLE Tech (Франция/США), SAF (Германия/Голландия), BPW (Германия/Венгрия), КАМАЗ (Россия);
- Высокая устойчивость к перегревам и температурным перепадам
- Эффективная тормозная динамика при различных стилях вождения.



Issue: (Original)	Date of Issue:
January 2008	30 January 2012
Issue Date:	IATF No:
January 2013	0123096



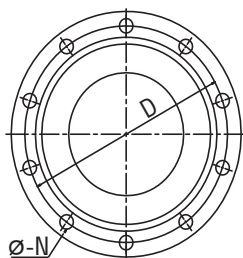
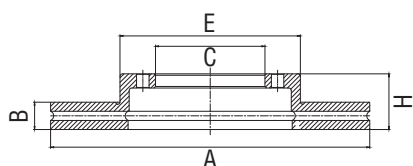

- A - Диаметр диска (мм)
- B - Толщина диска (мм)
- C - Диаметр центрирующего отверстия (мм)
- H - Высота диска (мм)
- D - Диаметр окружности расположения крепежных отверстий (мм)
- N - Количество крепежных отверстий
- E - Диаметр ступицы
- Q - Размер крепежного отверстия

260201

LADA

2108-09

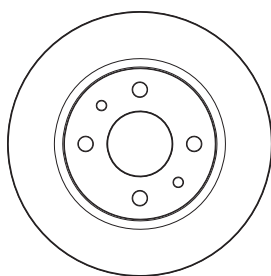

PC

A	B	C	H	D	E	N	Ø
239	12	58,5	42,5	98	137,25	4+2	13

O.E.M.

21083501070

Поз.



260202

LADA

2101-07

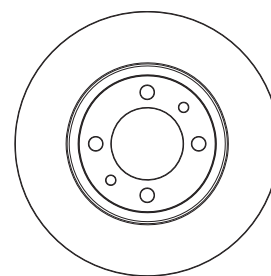

PC

A	B	C	H	D	E	N	Ø
252	10,5	68,3	65	98	130,5	4+2	13

O.E.M.

21013501070

Поз.



260205

LADA

2121 (4x4)

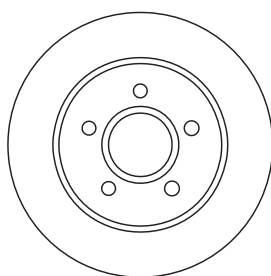

PC

A	B	C	H	D	E	N	Ø
272	11	108	50,5	139,5	169,25	5	14,5

O.E.M.

21213501070

Поз.



260206

LADA

2112 R14

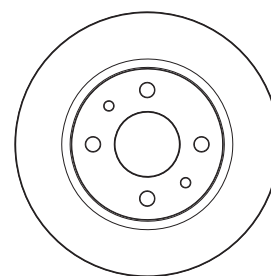

PC

A	B	C	H	D	E	N	Ø
260	20	58,5	42,5	98	137,3	4	13

O.E.M.

21123501070

Поз.



260207

LADA

2110 R13

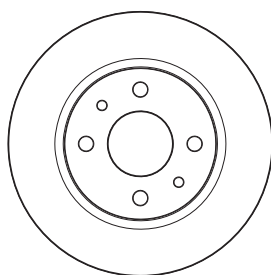

PC

A	B	C	H	D	E	N	Ø
239	20	58,5	42,5	98	137,3	4	13

O.E.M.

21103501070

Поз.



550201

GAZ

GAZELLE 3302

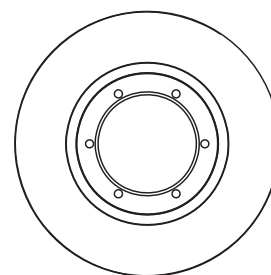

PC

A	B	C	H	D	E	N	Ø
280	21	104	74	122	150	6	M10x1,5

O.E.M.

33023501078

Поз.



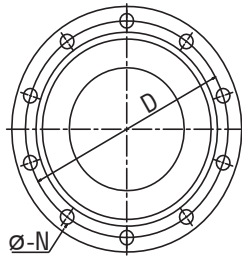
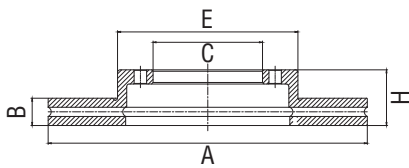

A - Диаметр диска (мм)
 B - Толщина диска (мм)
 C - Диаметр центрирующего отверстия (мм)
 H - Высота диска (мм)
 D - Диаметр окружности расположения крепежных отверстий (мм)
 N - Количество крепежных отверстий
 E - Диаметр ступицы
 Q - Размер крепежного отверстия

320222

AUDI

AUDI 100,A4,A6

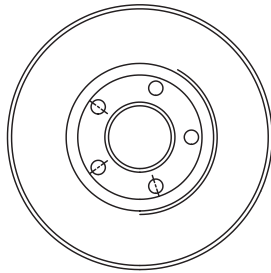

PC

A	B	C	H	D	E	N	Ø
287,8	24,8	68,2	46,3	112	148,1	5	15,5

O.E.M.

8E0615301Q

Поз.



320223

AUDI

AUDI A4,A8

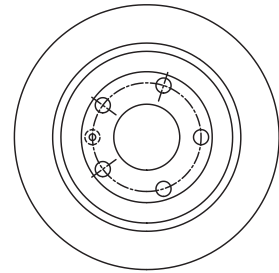

PC

A	B	C	H	D	E	N	Ø
279,8	22	68,04	46,4	112	145,8	5+1	15,6

O.E.M.

8E0615301D

Поз.



410201

AUDI

AUDI A1,A3

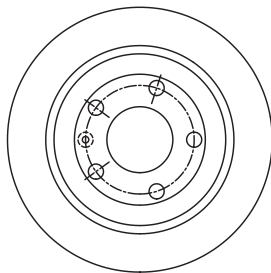

LCV

A	B	C	H	D	E	N	Ø
256	22	65	36,5	100	146	5+1	15,8

O.E.M.

1J0615301D/1J0615301L/
 6R0615301/8Z0615301B/
 8Z0615301D/1J0615301

Поз.



410208

AUDI

AUDI A3

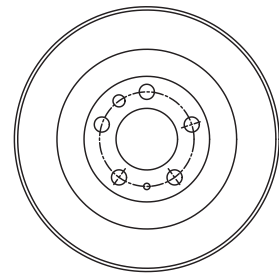

PC

A	B	C	H	D	E	N	Ø
279,8	22	65	36,6	100	145	5+1+1	16,1

O.E.M.

1J0615301E/1J0615301M

Поз.



410215

AUDI

AUDI A3

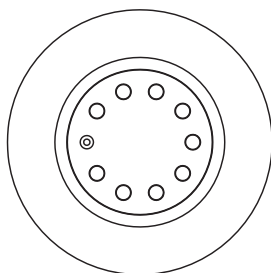

LCV

A	B	C	H	D	E	N	Ø
280	22	65	49,5	112	154,2	9+1	15,3

O.E.M.

1K0615301S/1K0615301AC

Поз.



410228

AUDI

AUDI A3

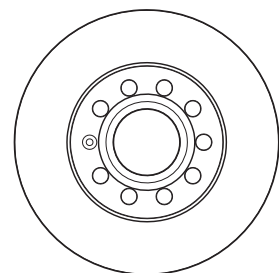

LCV

A	B	C	H	D	E	N	Ø
260	12	65	48	112	150,1	9+1	15,3

O.E.M.

1K0615601L

Поз.



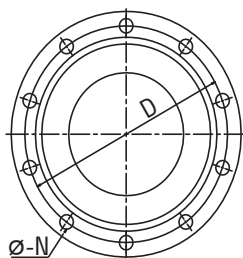
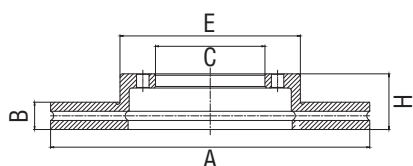

- A - Диаметр диска (мм)
- B - Толщина диска (мм)
- C - Диаметр центрирующего отверстия (мм)
- H - Высота диска (мм)
- D - Диаметр окружности расположения крепежных отверстий (мм)
- N - Количество крепежных отверстий
- E - Диаметр ступицы
- Q - Размер крепежного отверстия

410237

AUDI

AUDI A1,A3

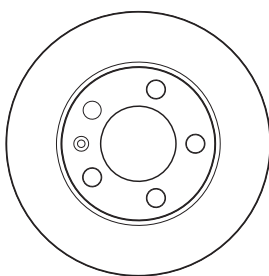

PC

A	B	C	H	D	E	N	Ø
232	9	65	39	100	135	5+1	15,8

O.E.M.

1J0615601

Поз.



410243

AUDI

AUDI 100,A6

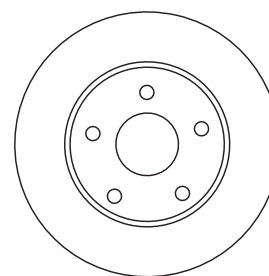

PC

A	B	C	H	D	E	N	Ø
244,8	10	68,2	63,7	112	145,6	5	15,5

O.E.M.

4A0615601A

Поз.



380210

CHEVROLET

CHEVROLET LANOS

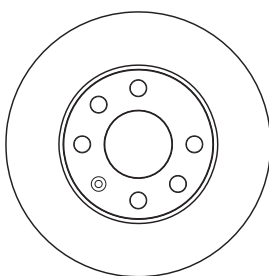

PC

A	B	C	H	D	E	N	Ø
236	20	60	41	100	133,7	6+1	14,2

O.E.M.

90121445/90008006

Поз.



510216

CHEVROLET

CHEVROLET SPARK

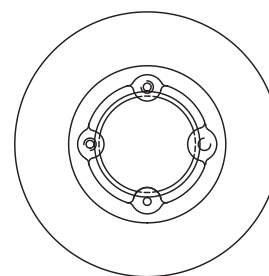

PC

A	B	C	H	D	E	N	Ø
235,8	12,5	86,1	35,4	102	121	4	M10x1,25

O.E.M.

96284392

Поз.



510217

CHEVROLET

CHEVROLET LACETTI,REZZO

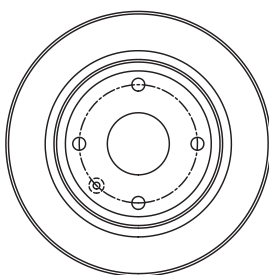

PC

A	B	C	H	D	E	N	Ø
256	24	60	47,3	114,3	153,9	4+1	12,5

O.E.M.

96549782

Поз.



510218

CHEVROLET

CHEVROLET AVEO,SPARK

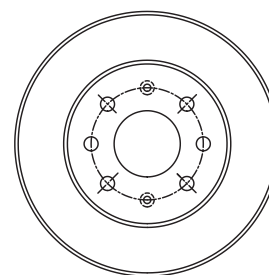

PC

A	B	C	H	D	E	N	Ø
235,8	20	59	41	100	133,5	6+2	12,6

O.E.M.

96574633

Поз.



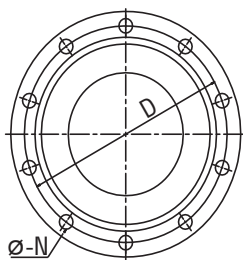
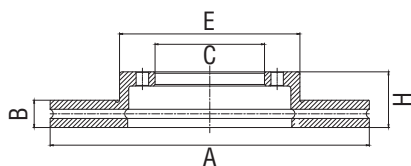

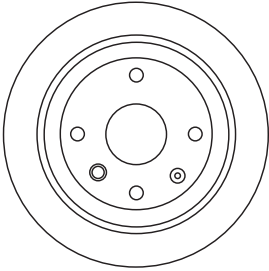

A - Диаметр диска (мм)
 B - Толщина диска (мм)
 C - Диаметр центрирующего отверстия (мм)
 H - Высота диска (мм)
 D - Диаметр окружности расположения крепежных отверстий (мм)
 N - Количество крепежных отверстий
 E - Диаметр ступицы
 Q - Размер крепежного отверстия

510219 **PC**
CHEVROLET
 CHEVROLET LACETTI





A	B	C	H	D	E	N	Ø
257,8	10,5	60	57,3	114,3	181,8	4+1+1	12,5

O.E.M. 96549630 **Поз.**  

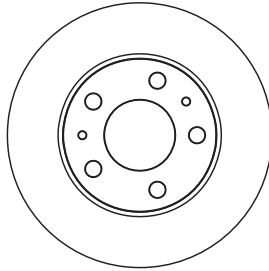
230216 **LCV**
CITROEN
 CITROEN JUMPER





A	B	C	H	D	E	N	Ø
300	32	80,05	73,5	130	174	5+2	18

O.E.M. 51705758/51740249 **Поз.**  

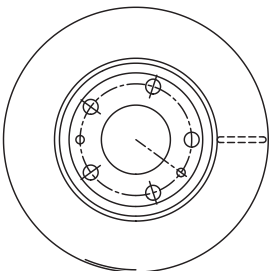
230235 **LCV**
CITROEN
 CITROEN JUMPER





A	B	C	H	D	E	N	Ø
279,8	24	73	65,5	118	155	5+2	15,7

O.E.M. 4246Y1/46806233 **Поз.**  

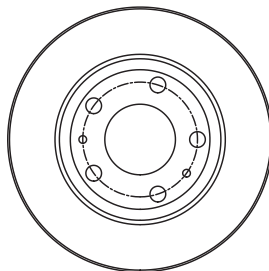
230236 **LCV**
CITROEN
 CITROEN JUMPER





A	B	C	H	D	E	N	Ø
299,8	24	80	65,5	130	174	5+2	17,7

O.E.M. 4246Y3/51728378 **Поз.**  

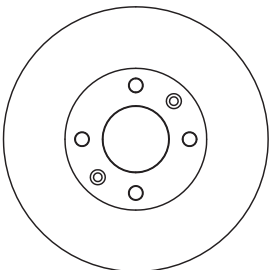
420201 **LCV**
CITROEN
 CITROEN C3, C4, C5,
 BERLINGO, XSARA





A	B	C	H	D	E	N	Ø
266	22	66,02	34	108	142,5	4+2	13

O.E.M. 4246W7 **Поз.**  

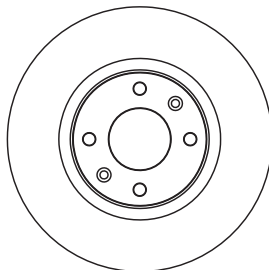
420211 **PC**
CITROEN
 CITROEN C3, C4, C5,
 BERLINGO, XSARA



A	B	C	H	D	E	N	Ø
283	26	66	34	108	143,3	4+2	13

O.E.M. 4246W8 **Поз.**  

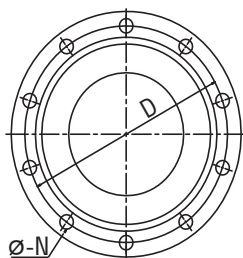
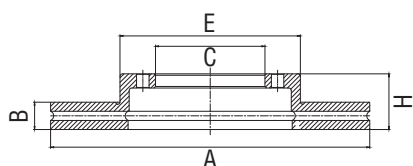

- A - Диаметр диска (мм)
- B - Толщина диска (мм)
- C - Диаметр центрирующего отверстия (мм)
- H - Высота диска (мм)
- D - Диаметр окружности расположения крепежных отверстий (мм)
- N - Количество крепежных отверстий
- E - Диаметр ступицы
- Q - Размер крепежного отверстия

380210

DAEWOO

DAEWOO NEXIA R13

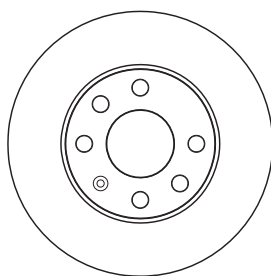

PC

A	B	C	H	D	E	N	Ø
236	20	60	41	100	133,7	6+1	14,2

O.E.M.

90121445/90008006

Поз.



380211

DAEWOO

DAEWOO NEXIA R14, ESPERO

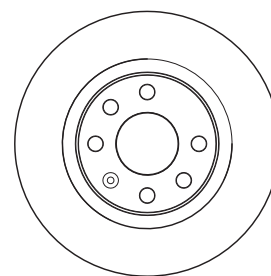

PC

A	B	C	H	D	E	N	Ø
256	24	60	41	100	133,75	6+1	14,2

O.E.M.

96179110/569042

Поз.



510216

DAEWOO

DAEWOO MATIZ

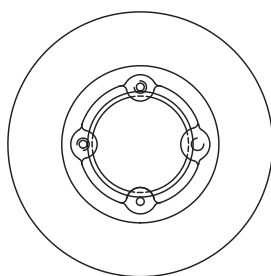

PC

A	B	C	H	D	E	N	Ø
235,8	12,5	86,1	35,4	102	121	4	M10x1,25

O.E.M.

96284392

Поз.



510217

DAEWOO

DAEWOO NUBIRA, REZZO

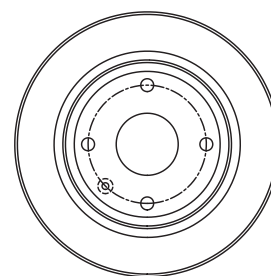

PC

A	B	C	H	D	E	N	Ø
256	24	60	47,3	114,3	153,9	4+1	12,5

O.E.M.

96549782

Поз.



510218

DAEWOO

DAEWOO KALOS, LANOS

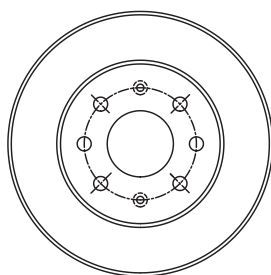

PC

A	B	C	H	D	E	N	Ø
235,8	20	59	41	100	133,5	6+2	12,6

O.E.M.

96574633

Поз.



510219

DAEWOO

DAEWOO NUBIRA

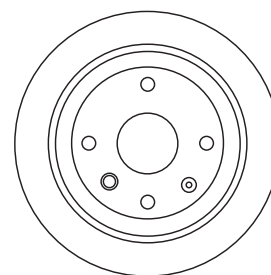

PC

A	B	C	H	D	E	N	Ø
257,8	10,5	60	57,3	114,3	181,8	4+1+1	12,5

O.E.M.

96549630

Поз.



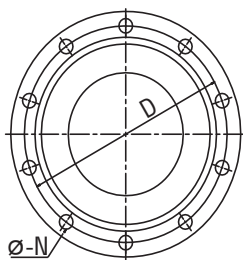
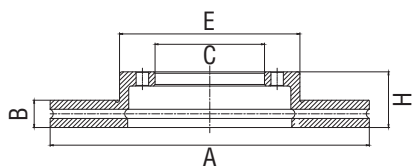

A - Диаметр диска (мм)
 B - Толщина диска (мм)
 C - Диаметр центрирующего отверстия (мм)
 H - Высота диска (мм)
 D - Диаметр окружности расположения крепежных отверстий (мм)
 N - Количество крепежных отверстий
 E - Диаметр ступицы
 Q - Размер крепежного отверстия



230201 **PC**

FIAT

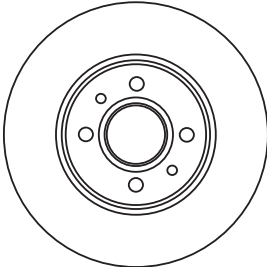
FIAT BRAVO, DOBLO



A	B	C	H	D	E	N	Ø
257	20	59,015	40,5	98	137	4+2	13

O.E.M. 46423415 **Поз.**  



230206 **PC**

FIAT

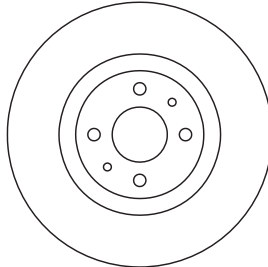
FIAT DOBLO PANORAMA



A	B	C	H	D	E	N	Ø
284	22	59,015	43,5	98	137	4+2	13,2

O.E.M. 46455892 **Поз.**  



230207 **LCV**

FIAT

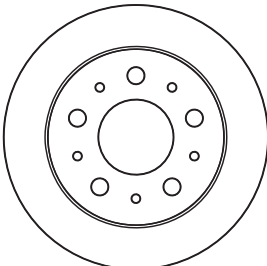
FIAT DUCATO



A	B	C	H	D	E	N	Ø
280	16	79,02	82	130	186	5+5	17,65

O.E.M. 46833807 **Поз.**  



230208 **PC**

FIAT

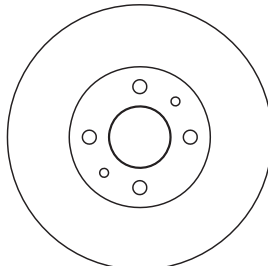
FIAT DOBLO CARGO



A	B	C	H	D	E	N	Ø
257	22	59,015	40,5	98	137,5	4+2	13,2

O.E.M. 46401356 **Поз.**  



230214 **LCV**

FIAT

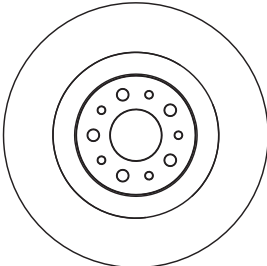
FIAT DOBLO NEW



A	B	C	H	D	E	N	Ø
305	28	59	45,75	98	138	5+5	13

O.E.M. 51897455 **Поз.**  



230216 **LCV**

FIAT

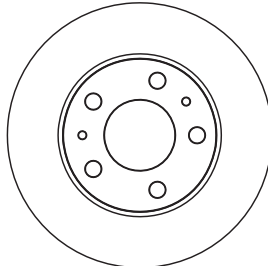
FIAT DUCATO



A	B	C	H	D	E	N	Ø
300	32	80,05	73,5	130	174	5+2	18

O.E.M. 51705758/51740249 **Поз.**  

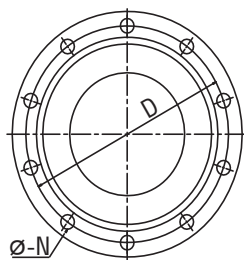
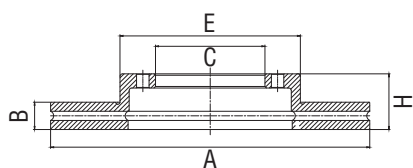

- A - Диаметр диска (мм)
- B - Толщина диска (мм)
- C - Диаметр центрирующего отверстия (мм)
- H - Высота диска (мм)
- D - Диаметр окружности расположения крепежных отверстий (мм)
- N - Количество крепежных отверстий
- E - Диаметр ступицы
- Q - Размер крепежного отверстия

230235

FIAT

FIAT DUCATO

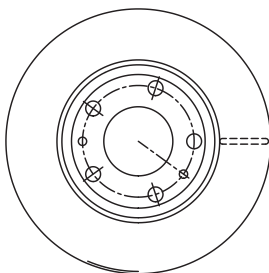

LCV

A	B	C	H	D	E	N	Ø
279,8	24	73	65,5	118	155	5+2	15,7

O.E.M.

4246Y1/46806233

Поз.



230236

FIAT

FIAT DUCATO

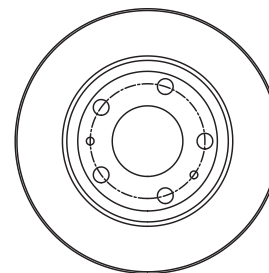

LCV

A	B	C	H	D	E	N	Ø
299,8	24	80	65,5	130	174	5+2	17,7

O.E.M.

4246Y3/51728378

Поз.



380213

FIAT

FIAT GRANDE PUNTO 06->

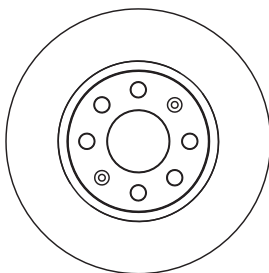

PC

A	B	C	H	D	E	N	Ø
257	22	60	40,5	100	137,3	6+2	14,5

O.E.M.

569024/51806103

Поз.



020201

FORD

FORD TRANSIT 00-06

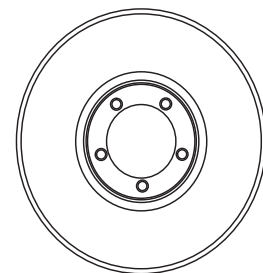

LCV

A	B	C	H	D	E	N	Ø
294	24,3	81,94	42,9	100	130,5	5	M10x1,5

O.E.M.

1387781

Поз.



020203

FORD

FORD TRANSIT CONNECT,
TOURNEO CONNECT 02-

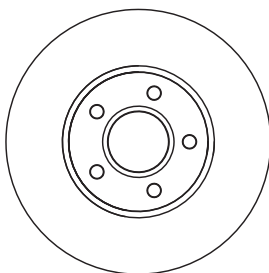

LCV

A	B	C	H	D	E	N	Ø
278	24	63,46	44,5	107,5	146	5	13,75

O.E.M.

4457985

Поз.



020204

FORD

FORD FOCUS I, FUSION, FIESTA

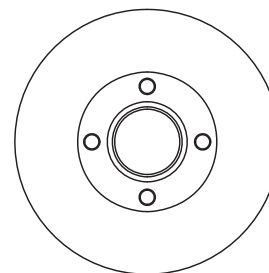

PC

A	B	C	H	D	E	N	Ø
258	22	63,6	43,2	108	146	4	13,8

O.E.M.

1323620/DD323325X

Поз.



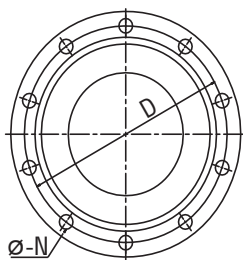
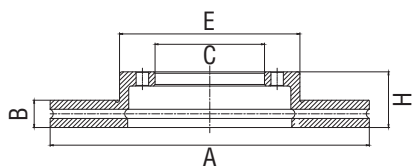

A - Диаметр диска (мм)
 B - Толщина диска (мм)
 C - Диаметр центрирующего отверстия (мм)
 H - Высота диска (мм)
 D - Диаметр окружности расположения крепежных отверстий (мм)
 N - Количество крепежных отверстий
 E - Диаметр ступицы
 Q - Размер крепежного отверстия

020205 **LCV**
FORD
 FORD TRANSITC 2006

A	B	C	H	D	E	N	Ø
300	28	93	54,5	111,5	154	5	M10x1,5

O.E.M. 1543340 **Поз.**

020207 **LCV**
FORD
 FORD TRANSIT 06->

A	B	C	H	D	E	N	Ø
280	16	119,6	68,8	160	180,2	5	M10x1,5

O.E.M. 1451161 **Поз.**

020208 **PC**
FORD
 FORD MONDEO III 00->

A	B	C	H	D	E	N	Ø
300	24	63,55	47	108	165	5+2	13,8

O.E.M. 4110587 **Поз.**

020209 **PC**
FORD
 FORD FOCUS I 98->

A	B	C	H	D	E	N	Ø
252,6	10	63,7	33	107,95	164,8	4	14

O.E.M. 1323621 **Поз.**

020213 **PC**
FORD
 FORD FIESTA 1.4 95-02

A	B	C	H	D	E	N	Ø
239,5	12	63,54	43	107,95	146	4	13,75

O.E.M. 1112542 **Поз.**

020215 **PC**
FORD
 FORD FOCUS II, FOCUS III,
 C-MAX

A	B	C	H	D	E	N	Ø
278	25	63,6	48,5	107,95	148,3	5	13,75

O.E.M. 1223665/31262718 **Поз.**

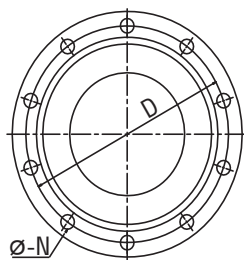
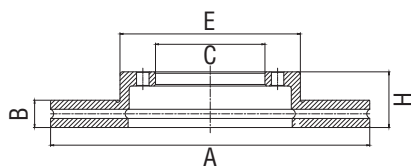

- A - Диаметр диска (мм)
- B - Толщина диска (мм)
- C - Диаметр центрирующего отверстия (мм)
- H - Высота диска (мм)
- D - Диаметр окружности расположения крепежных отверстий (мм)
- N - Количество крепежных отверстий
- E - Диаметр ступицы
- Q - Размер крепежного отверстия

020216

FORD

FORD FOCUS II,C-MAX

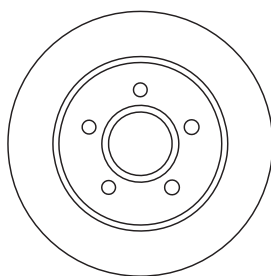

PC

A	B	C	H	D	E	N	Ø
265	11	63,6	41	107,95	163	5	13,75

O.E.M.

1223540

Поз.



020218

FORD

FORD TRANSIT CONNECT,
TOURNEO CONNECT 02->

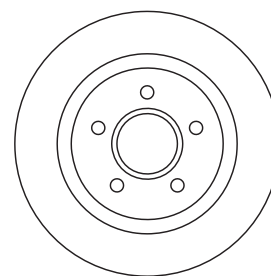

LCV

A	B	C	H	D	E	N	Ø
278	11	63,6	53,7	108	159,5	5	13,8

O.E.M.

1362868

Поз.



020219

FORD

FORD FOCUS II, FOCUS III,
C-MAX

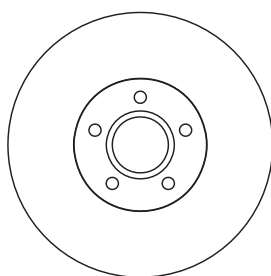

PC

A	B	C	H	D	E	N	Ø
300	25	63,55	48,5	107,95	150,2	5	13,75

O.E.M.

1323560/31262719

Поз.



020220

FORD

FORD TRANSIT 00-06

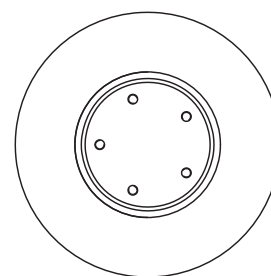

LCV

A	B	C	H	D	E	N	Ø
277	24	81,94	42,5	100	130,5	5	M10x1,5

O.E.M.

4041427

Поз.



020221

FORD

FORD TRANSIT 06->

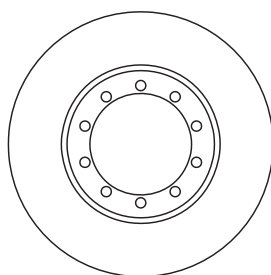

LCV

A	B	C	H	D	E	N	Ø
280	16	107,53	16,3	124	-	10	10,75

O.E.M.

1464031

Поз.



020222

FORD

FORD TRANSIT 06->

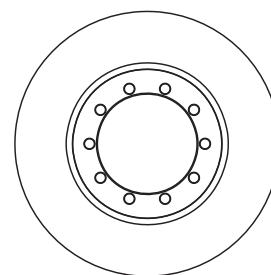

LCV

A	B	C	H	D	E	N	Ø
284	16	147,5	44	124	160	10	10,75

O.E.M.

1488311

Поз.



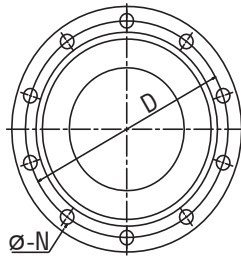
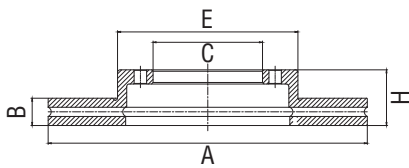

A - Диаметр диска (мм)
 B - Толщина диска (мм)
 C - Диаметр центрирующего отверстия (мм)
 H - Высота диска (мм)
 D - Диаметр окружности расположения крепежных отверстий (мм)
 N - Количество крепежных отверстий
 E - Диаметр ступицы
 Q - Размер крепежного отверстия

020223

FORD

FORD TRANSIT 06->

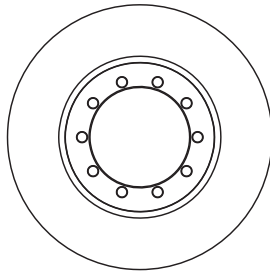

LCV

A	B	C	H	D	E	N	Ø
280	28	93	54,5	111,5	154	5	M10x1,5

O.E.M.

1503287

Поз.



020226

FORD

FORD FIESTA VI 08->

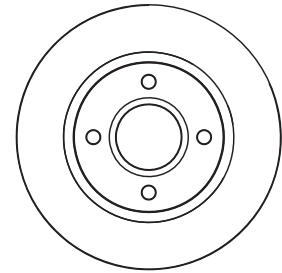

PC

A	B	C	H	D	E	N	Ø
258	23	63,55	44	107,95	146,3	4	13,2

O.E.M.

1523795

Поз.



020228

FORD

FORD FOCUS II 04->

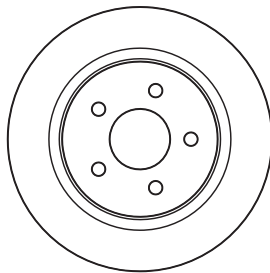

PC

A	B	C	H	D	E	N	Ø
280	11	63,5	40,7	107,95	165	5	13,75

O.E.M.

1223566/30769113

Поз.



020255

FORD

FORD MONDEO III 00->

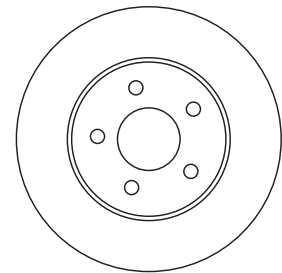

PC

A	B	C	H	D	E	N	Ø
279,9	12	63,7	34,2	107,95	165	5	14

O.E.M.

4098427

Поз.



440218

FORD

FORD GALAXY, KUGA,
MONDEO IV

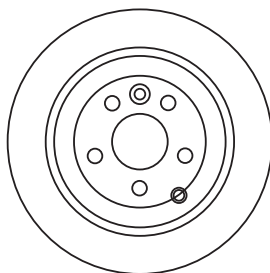

PC

A	B	C	H	D	E	N	Ø
300	28	63,7	52,1	108	150	5+1	15,6

O.E.M.

1379965/LR000571

Поз.



290201

HYUNDAI

HYUNDAI PORTER,
H-100, STAREX

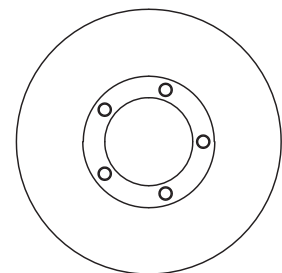

LCV

A	B	C	H	D	E	N	Ø
253	20	84	28,5	104	124	5	10,6

O.E.M.

58129-44010

Поз.



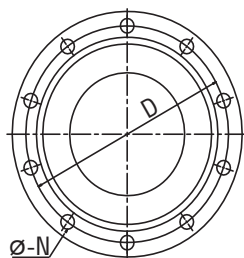
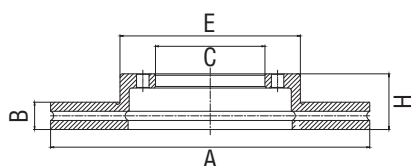

- A - Диаметр диска (мм)
- B - Толщина диска (мм)
- C - Диаметр центрирующего отверстия (мм)
- H - Высота диска (мм)
- D - Диаметр окружности расположения крепёжных отверстий (мм)
- N - Количество крепёжных отверстий
- E - Диаметр ступицы
- Q - Размер крепёжного отверстия

290202

HYUNDAI

HYUNDAI ACCENT

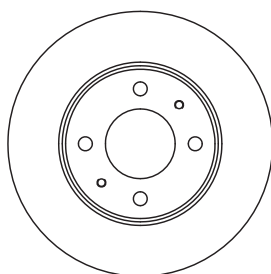

PC

A	B	C	H	D	E	N	Ø
241	19	63,4	52,4	100	142	4+2	12,65

O.E.M.

51712-25060

Поз.



290203

HYUNDAI

HYUNDAI TUCSON, SONATA NF

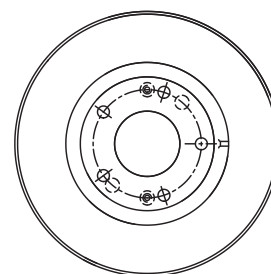

PC

A	B	C	H	D	E	N	Ø
279,8	26	69	47,3	114,3	152,3	5+2	12,7

O.E.M.

51712-1F300/51712-2C000

Поз.



290204

HYUNDAI

HYUNDAI GETZ

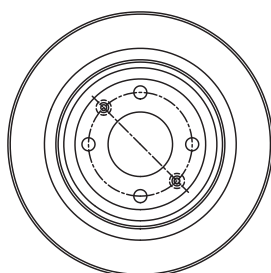

PC

A	B	C	H	D	E	N	Ø
255,4	19	62,2	48	100	143,9	4+2	12,6

O.E.M.

51712-1C050

Поз.



290205

HYUNDAI

HYUNDAI SANTA FE (SM)

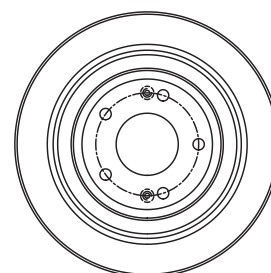

PC

A	B	C	H	D	E	N	Ø
294,1	26,06	69,02	46,2	114,3	158	5+2	12,6

O.E.M.

51712-26100

Поз.



290206

HYUNDAI

HYUNDAI ELANTRA XD, SONATA IV

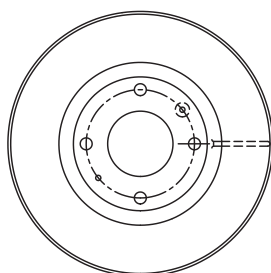

PC

A	B	C	H	D	E	N	Ø
279,8	26	69	47,3	114,3	152,3	4+2	12,7

O.E.M.

51712-3D300

Поз.



290212

HYUNDAI

HYUNDAI H-1, STAREX

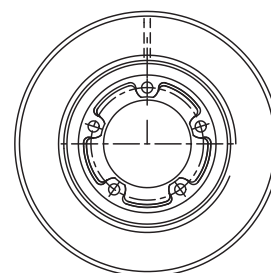

LCV

A	B	C	H	D	E	N	Ø
253,9	24	87,05	48,5	107,95	128,9	5	10,6

O.E.M.

58129-4A000

Поз.



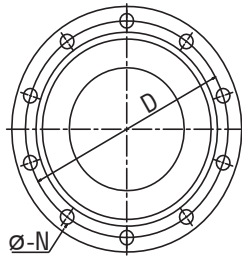
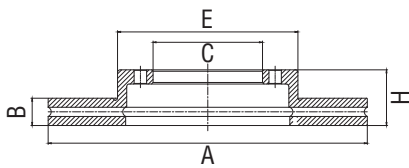

A - Диаметр диска (мм)
 B - Толщина диска (мм)
 C - Диаметр центрирующего отверстия (мм)
 H - Высота диска (мм)
 D - Диаметр окружности расположения крепежных отверстий (мм)
 N - Количество крепежных отверстий
 E - Диаметр ступицы
 Q - Размер крепежного отверстия

290213

HYUNDAI

HYUNDAI SONATA IV, MATRIX

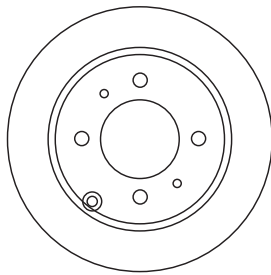

PC

A	B	C	H	D	E	N	Ø
262	10	76	61	114,3	182	4+2+1	12,5

O.E.M.

58411-38310

Поз.



290214

HYUNDAI

HYUNDAI ACCENT, GETZ

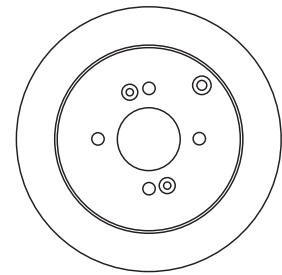

PC

A	B	C	H	D	E	N	Ø
262	10	62,5	63,8	100	182	4+2+1	12,5

O.E.M.

58411-1C800

Поз.



290215

HYUNDAI

HYUNDAI SONATA V, TUCSON

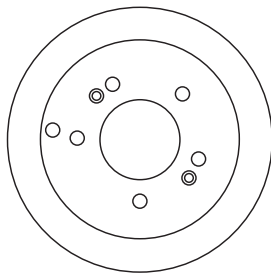

PC

A	B	C	H	D	E	N	Ø
262	10	76	61,1	114,3	182	5+2+1	12,6

O.E.M.

58411-39600

Поз.



290216

HYUNDAI

HYUNDAI SANTA FE (SM),
TUCSON (JM)

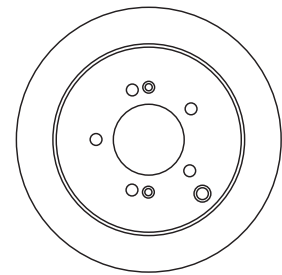

PC

A	B	C	H	D	E	N	Ø
284	10	76	61,1	114,3	202,1	5+2+1	12,6

O.E.M.

58411-3A300

Поз.



290217

HYUNDAI

HYUNDAI SOLARIS

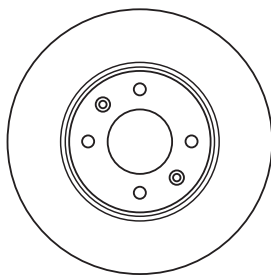

PC

A	B	C	H	D	E	N	Ø
256	22	62,2	44	100	144	4+2	12,5

O.E.M.

51712-0U000

Поз.



290203

KIA

KIA SPORTAGE, CEED 04-

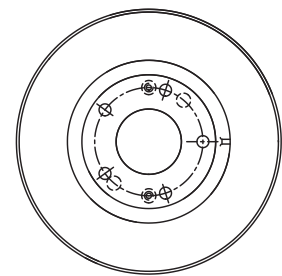

PC

A	B	C	H	D	E	N	Ø
279,8	26	69	47,3	114,3	152,3	5+2	12,7

O.E.M.

51712-1F300/51712-2C000

Поз.



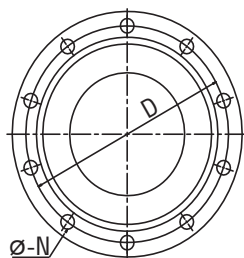
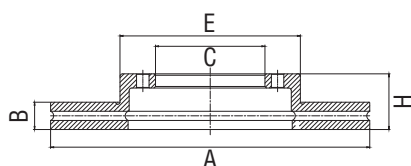

- A - Диаметр диска (мм)
- B - Толщина диска (мм)
- C - Диаметр центрирующего отверстия (мм)
- H - Высота диска (мм)
- D - Диаметр окружности расположения крепежных отверстий (мм)
- N - Количество крепежных отверстий
- E - Диаметр ступицы
- Q - Размер крепежного отверстия

290206

KIA

KIA MAGENTIS

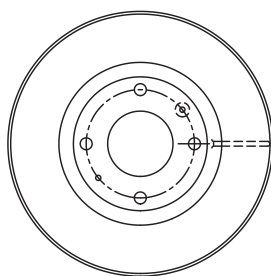

PC

A	B	C	H	D	E	N	Ø
279,8	26	69	47,3	114,3	152,3	4+2	12,7

O.E.M.

51712-3D300

Поз.



290213

KIA

KIA MAGENTIS

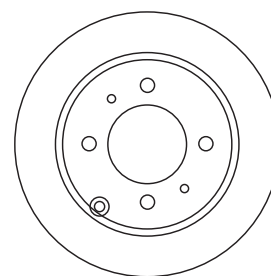

PC

A	B	C	H	D	E	N	Ø
262	10	76	61	114,3	182	4+2+1	12,5

O.E.M.

58411-38310

Поз.



290214

KIA

KIA RIO II

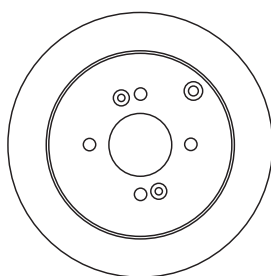

PC

A	B	C	H	D	E	N	Ø
262	10	62,5	63,8	100	182	4+2+1	12,5

O.E.M.

58411-1C800

Поз.



290215

KIA

KIA MAGENTIS,SPORTAGE

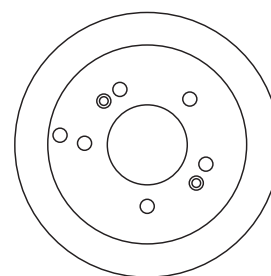

PC

A	B	C	H	D	E	N	Ø
262	10	76	61,1	114,3	182	5+2+1	12,6

O.E.M.

58411-39600

Поз.



290216

KIA

KIA SPORTAGE

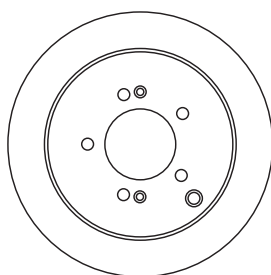

PC

A	B	C	H	D	E	N	Ø
284	10	76	61,1	114,3	202,1	5+2+1	12,6

O.E.M.

58411-3A300

Поз.



290217

KIA

KIA RIO III

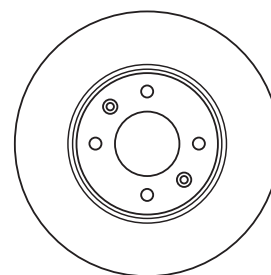

PC

A	B	C	H	D	E	N	Ø
256	22	62,2	44	100	144	4+2	12,5

O.E.M.

51712-0U000

Поз.



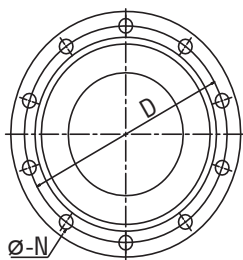
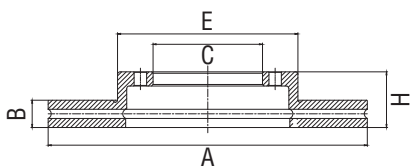

A - Диаметр диска (мм)
 B - Толщина диска (мм)
 C - Диаметр центрирующего отверстия (мм)
 H - Высота диска (мм)
 D - Диаметр окружности расположения крепежных отверстий (мм)
 N - Количество крепежных отверстий
 E - Диаметр ступицы
 Q - Размер крепежного отверстия

340210

KIA

KIA SPECTRA (Ижевск)

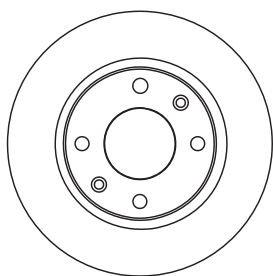

PC

A	B	C	H	D	E	N	Ø
258	24	57	48,5	100		4	13,1

O.E.M.

0K2N133251

Поз.



340211

KIA

KIA SPORTAGE 00-05

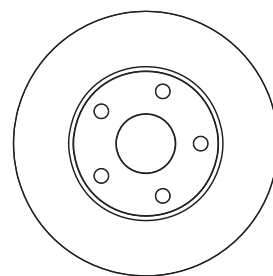

PC

A	B	C	H	D	E	N	Ø
284	24	96,3	51	139,7		5	12,5

O.E.M.

0K0113325XC

Поз.



340212

KIA

KIA RIO ->05

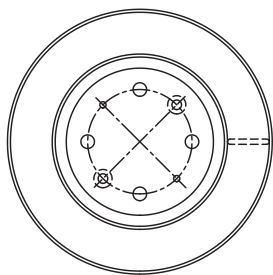

PC

A	B	C	H	D	E	N	Ø
253,7	24	55,05	50,7	100	152,7	4+2+2	13

O.E.M.

51712-FD300

Поз.



020204

MAZDA

MAZDA 2 03->

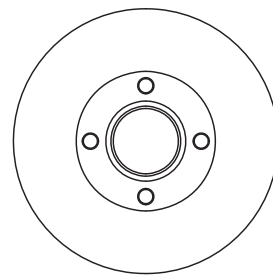

PC

A	B	C	H	D	E	N	Ø
258	22	63,6	43,2	108	146	4	13,8

O.E.M.

1323620/DD323325X

Поз.



350212

MAZDA

MAZDA 3,5 1.6 03-09

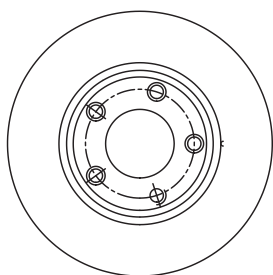

PC

A	B	C	H	D	E	N	Ø
278	24,9	72	48,5	114,3	148,7	5	13,9

O.E.M.

BP4Y3325XB

Поз.



350213

MAZDA

MAZDA 3,5 2.0 03-09

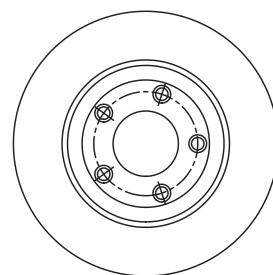

PC

A	B	C	H	D	E	N	Ø
299,8	24,9	72	48,5	114,3	150,5	5	13,9

O.E.M.

BP6Y3325XF

Поз.



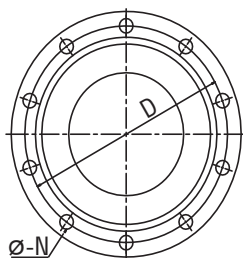
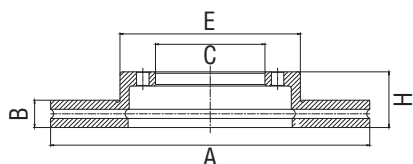

- A - Диаметр диска (мм)
- B - Толщина диска (мм)
- C - Диаметр центрирующего отверстия (мм)
- H - Высота диска (мм)
- D - Диаметр окружности расположения крепёжных отверстий (мм)
- N - Количество крепёжных отверстий
- E - Диаметр ступицы
- Q - Размер крепёжного отверстия

350221

MAZDA

MAZDA 3 2.0 03-09

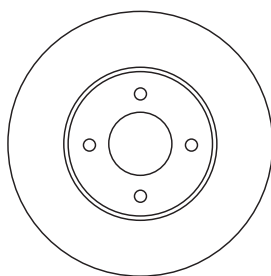

PC

A	B	C	H	D	E	N	Ø
279,8	10,9	72	40,7	114,3	164,8	5	13,9

O.E.M.

BP6Y26251B

Поз.



030205

MERCEDES

MB SPRINTER 06->

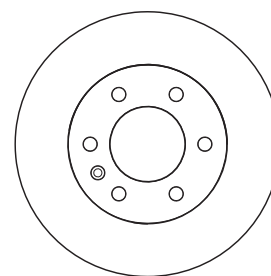

LCV

A	B	C	H	D	E	N	Ø
300	28	85	68,5	130	180,4	6+1	15,3

O.E.M.

9064210012 /2E0615301

Поз.



030206

MERCEDES

MB SPRINTER 97->

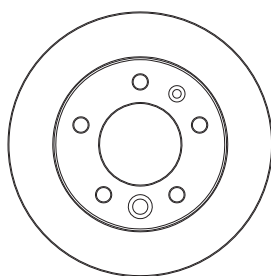

LCV

A	B	C	H	D	E	N	Ø
276	22	85	77	130	174	5+1+1	15,3

O.E.M.

9014210312/9024210312

Поз.



030207

MERCEDES

MB SPRINTER, G-Class

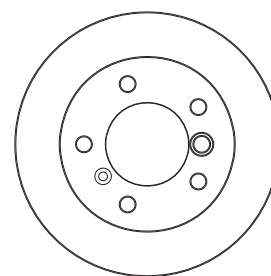

LCV

A	B	C	H	D	E	N	Ø
272,8	16	85	96,75	130	180,4	5+1+1	15,3

O.E.M.

9024230112/2D0615601A

Поз.



030211

MERCEDES

MB SPRINTER 06->

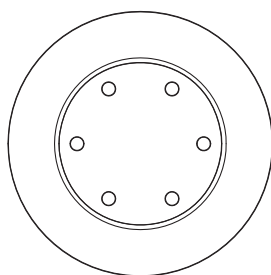

LCV

A	B	C	H	D	E	N	Ø
303	28	120	93	145	86	6	15,1

O.E.M.

9064230112/2E0615601

Поз.



030216

MERCEDES

MB SPRINTER 06->

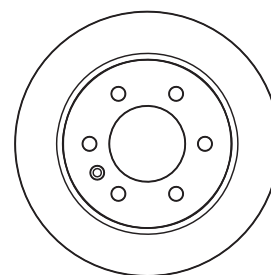

LCV

A	B	C	H	D	E	N	Ø
298	16,3	85	71,4	130	190	6+1	15,3

O.E.M.

9064230012

Поз.



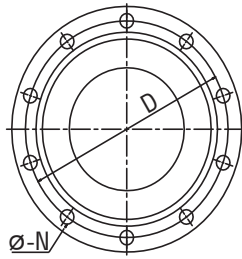
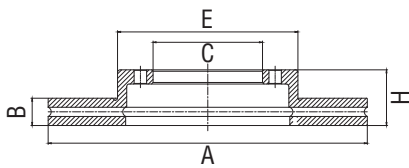

A - Диаметр диска (мм)
 B - Толщина диска (мм)
 C - Диаметр центрирующего отверстия (мм)
 H - Высота диска (мм)
 D - Диаметр окружности расположения крепежных отверстий (мм)
 N - Количество крепежных отверстий
 E - Диаметр ступицы
 Q - Размер крепежного отверстия

030243

MERCEDES

MB SPRINTER 95-06

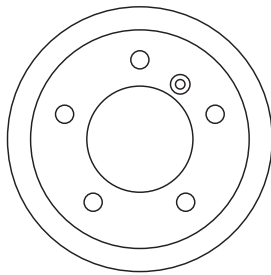

LCV

A	B	C	H	D	E	N	Ø
258,5	12	85,04	96,7	130	180,5	5+1	15,1

O.E.M.

9014230612

Поз.



030254

MERCEDES

MB SPRINTER 95-06

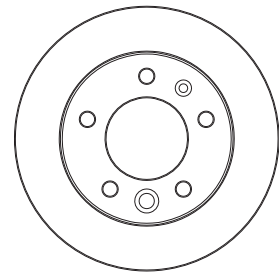

LCV

A	B	C	H	D	E	N	Ø
276	22	85	77	130	180,4	5	15

O.E.M.

9024210712/9014210312

Поз.



360201

MITSUBISHI

MITSUBISHI LANCER IX 03->

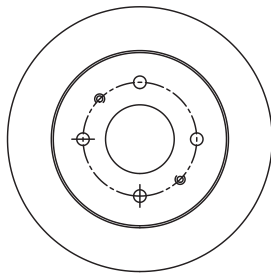

PC

A	B	C	H	D	E	N	Ø
276	26	69,05	45,6	114,3	156	4+2	12,6

O.E.M.

MR510742

Поз.



360202

MITSUBISHI

MITSUBISHI LANCER IX 03->

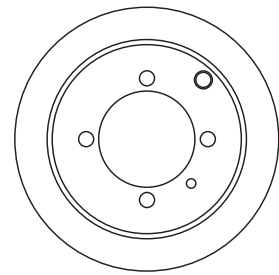

PC

A	B	C	H	D	E	N	Ø
262	10	90	60,2	114,3	181,7	4+2+1	12,5

O.E.M.

MB699964

Поз.



270222

NISSAN

NISSAN MICRA III,NOTE E11

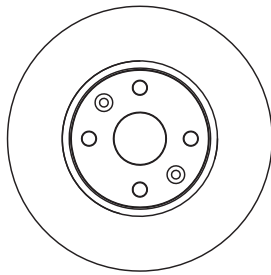

PC

A	B	C	H	D	E	N	Ø
260	22	61	44	100	135,8	4+2	13,6

O.E.M.

40206AX602/7701207795

Поз.



370227

NISSAN

NISSAN ALMERA N16,
PRIMERA P10,P11

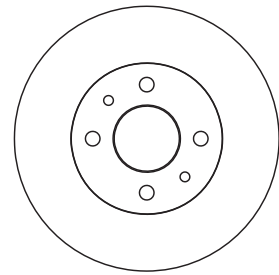

PC

A	B	C	H	D	E	N	Ø
257	22	68	49	114,3	154,5	4	12,8

O.E.M.

4020693J00

Поз.



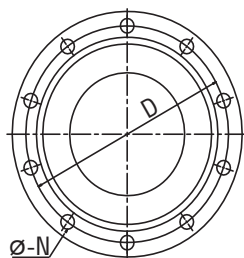
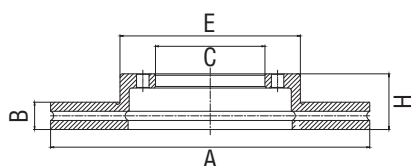

- A - Диаметр диска (мм)
- B - Толщина диска (мм)
- C - Диаметр центрирующего отверстия (мм)
- H - Высота диска (мм)
- D - Диаметр окружности расположения крепежных отверстий (мм)
- N - Количество крепежных отверстий
- E - Диаметр ступицы
- Q - Размер крепежного отверстия

370228

NISSAN

NISSAN QASHQAI, X-TRAIL 07->

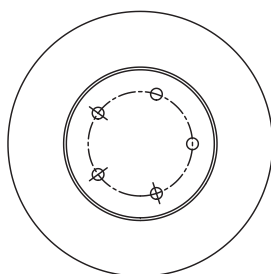

PC

A	B	C	H	D	E	N	Ø
296	26	68,04	44	114,3	156,8	5	12,8

O.E.M.

40206JG00A

Поз.



380204

OPEL

OPEL ASTRA G, ASTRA H,
ZAFIRA

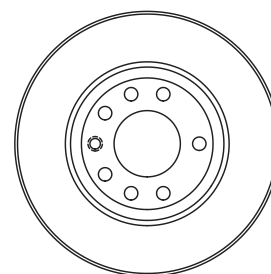

PC

A	B	C	H	D	E	N	Ø
279,7	25	70	42,2	110	150	7+1	14,25

O.E.M.

90539466

Поз.



380206

OPEL

OPEL ASTRA G

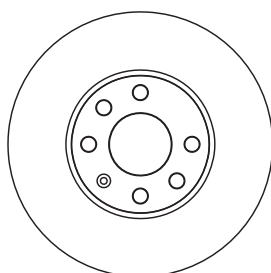

PC

A	B	C	H	D	E	N	Ø
256	23,85	60	41,1	100	133	6+1	14,2

O.E.M.

569059

Поз.



380210

OPEL

OPEL ASTRA, CORSA,
KADETT, VECTRA

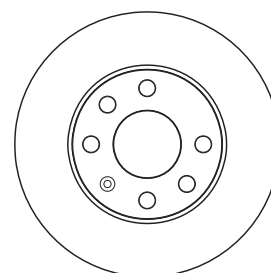

PC

A	B	C	H	D	E	N	Ø
236	20	60	41	100	133,7	6+1	14,2

O.E.M.

90121445/90008006

Поз.



380211

OPEL

OPEL ASTRA, CORSA,
KADETT, VECTRA

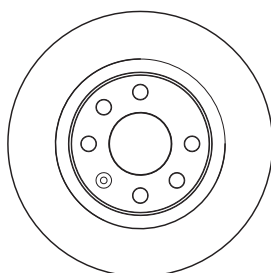

PC

A	B	C	H	D	E	N	Ø
256	24	60	41	100	133,75	6+1	14,2

O.E.M.

96179110/569042

Поз.



380213

OPEL

OPEL CORSA D 06->

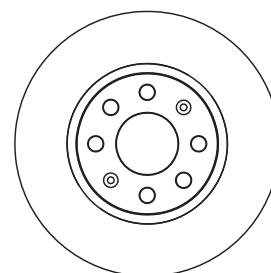

PC

A	B	C	H	D	E	N	Ø
257	22	60	40,5	100	137,3	6+2	14,5

O.E.M.

569024/51806103

Поз.



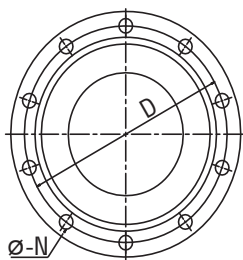
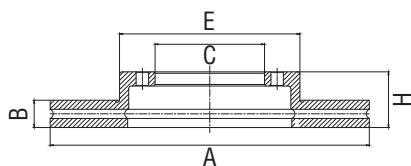

A - Диаметр диска (мм)
 B - Толщина диска (мм)
 C - Диаметр центрирующего отверстия (мм)
 H - Высота диска (мм)
 D - Диаметр окружности расположения крепежных отверстий (мм)
 N - Количество крепежных отверстий
 E - Диаметр ступицы
 Q - Размер крепежного отверстия



380241 **PC**

OPEL

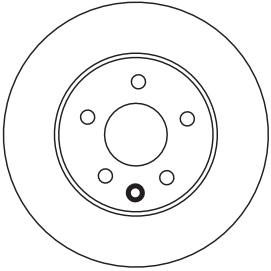
OPEL ASTRA G, ASTRA H, ZAFIRA



A	B	C	H	D	E	N	Ø
264	9,9	65,5	42	110	155	5+1	14,25

O.E.M. 90575113 **Поз.**  



510218 **PC**

OPEL

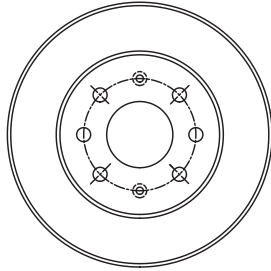
OPEL ASTRA, CORSA, VECTRA



A	B	C	H	D	E	N	Ø
235,8	20	59	41	100	133,5	6+2	12,6

O.E.M. 96574633 **Поз.**  



230216 **LCV**

PEUGEOT

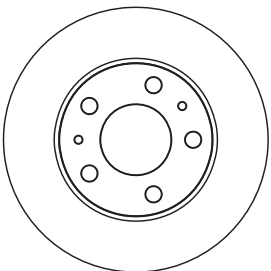
PEUGEOT BOXER



A	B	C	H	D	E	N	Ø
300	32	80,05	73,5	130	174	5+2	18

O.E.M. 51705758/51740249 **Поз.**  



230235 **LCV**

PEUGEOT

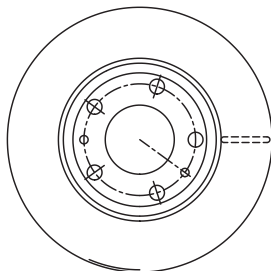
PEUGEOT BOXER



A	B	C	H	D	E	N	Ø
279,8	24	73	65,5	118	155	5+2	15,7

O.E.M. 4246Y1/46806233 **Поз.**  



230236 **LCV**

PEUGEOT

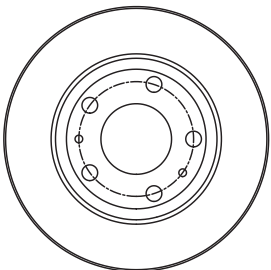
PEUGEOT BOXER



A	B	C	H	D	E	N	Ø
299,8	24	80	65,5	130	174	5+2	17,7

O.E.M. 4246Y3/51728378 **Поз.**  



420201 **LCV**

PEUGEOT

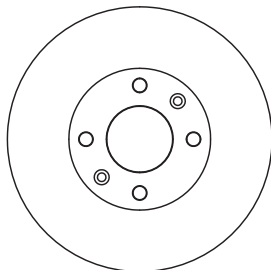
PEUGEOT 206, 207, 208, 307, PARTNER



A	B	C	H	D	E	N	Ø
266	22	66,02	34	108	142,5	4+2	13

O.E.M. 4246W7 **Поз.**  

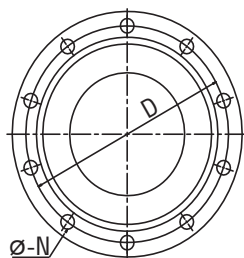
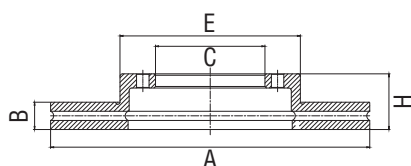

- A - Диаметр диска (мм)
- B - Толщина диска (мм)
- C - Диаметр центрирующего отверстия (мм)
- H - Высота диска (мм)
- D - Диаметр окружности расположения крепежных отверстий (мм)
- N - Количество крепежных отверстий
- E - Диаметр ступицы
- Q - Размер крепежного отверстия

420202

PEUGEOT

PEUGEOT 206, 405, PARTNER

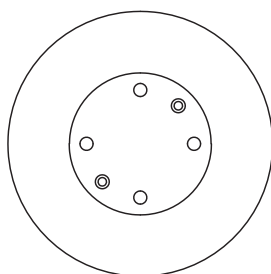

LCV

A	B	C	H	D	E	N	Ø
266	20,5	66,05	27,5	108	143,25	4+2	13

O.E.M.

4246R5

Поз.



420210

PEUGEOT

PEUGEOT 307, PARTNER

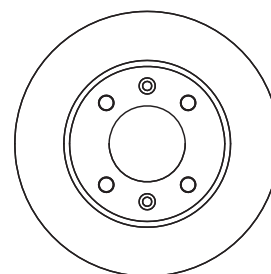

PC

A	B	C	H	D	E	N	Ø
247	9	71	35	108	144,8	4+2	13,2

O.E.M.

4246W9/4246X8

Поз.



420211

PEUGEOT

PEUGEOT 206, 207, 307, 308, PARTNER

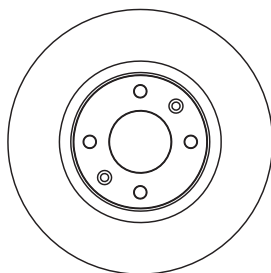

PC

A	B	C	H	D	E	N	Ø
283	26	66	34	108	143,3	4+2	13

O.E.M.

4246W8

Поз.



270201

RENAULT

RENAULT LOGAN, CLIO II, KANGOO

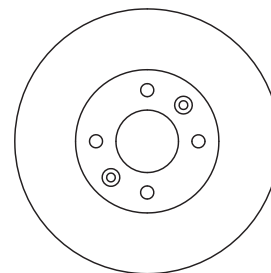

PC

A	B	C	H	D	E	N	Ø
258,75	20,6	61,01	41	100	140	4+2	12,75

O.E.M.

7701206339

Поз.



270202

RENAULT

RENAULT CLIO, KANGOO

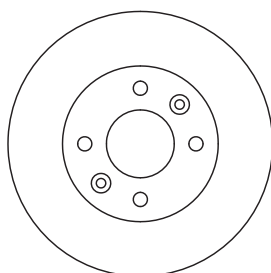

PC

A	B	C	H	D	E	N	Ø
238	20,1	61,01	41	100	140	4+2	12,75

O.E.M.

7701204286

Поз.



270203

RENAULT

RENAULT MEGANE I, II, KANGOO

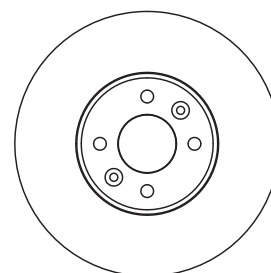

PC

A	B	C	H	D	E	N	Ø
280	24	61,01	43,8	100	151	4+2	13,5

O.E.M.

7701206118

Поз.



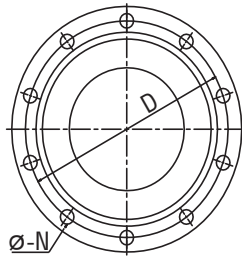
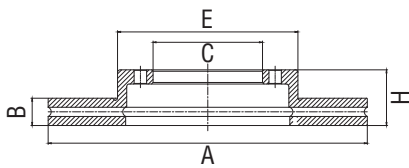

- A - Диаметр диска (мм)
- B - Толщина диска (мм)
- C - Диаметр центрирующего отверстия (мм)
- H - Высота диска (мм)
- D - Диаметр окружности расположения крепежных отверстий (мм)
- N - Количество крепежных отверстий
- E - Диаметр ступицы
- Q - Размер крепежного отверстия

270207

RENAULT

RENAULT LOGAN,
SANDERO с ABS

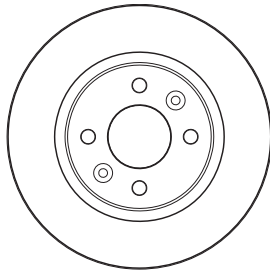

PC

A	B	C	H	D	E	N	Ø
258,5	12	61,01	41	100	140	4+2	13,5

O.E.M.

7701208252

Поз.



270222

RENAULT

RENAULT CLIO III, LOGAN,
MEGANE II

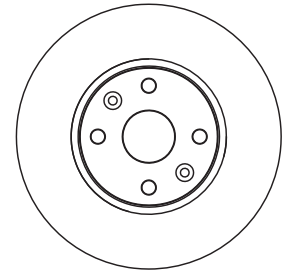

PC

A	B	C	H	D	E	N	Ø
260	22	61	44	100	135,8	4+2	13,6

O.E.M.

40206AX602/7701207795

Поз.



430204

RENAULT

RENAULT LOGAN ABS-

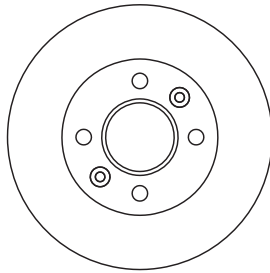

PC

A	B	C	H	D	E	N	Ø
235	20	61,01	51	100	139	4+2	13,8

O.E.M.

6001549211

Поз.

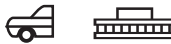

270218K

RENAULT

RENAULT MEGANE II

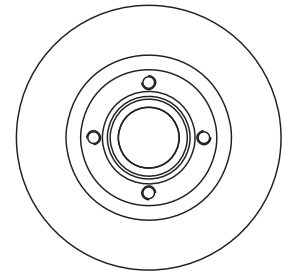

PC

A	B	C	H	D	E	N	Ø
240	8	54,9	80,2	100	135,8	4	M12x1,5

O.E.M.

7701207823

Поз.



270227

RENAULT

RENAULT MEGANE III,
FLUENCE, DUSTER

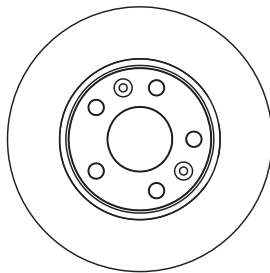

PC

A	B	C	H	D	E	N	Ø
280	24	68	44	114,3	151,3	5+2	15,8

O.E.M.

402060010R

Поз.



320222

SKODA

SKODA SUPERB (3U) 02-08

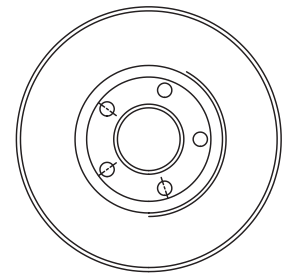

PC

A	B	C	H	D	E	N	Ø
287,8	24,8	68,2	46,3	112	148,1	5	15,5

O.E.M.

8E0615301Q

Поз.



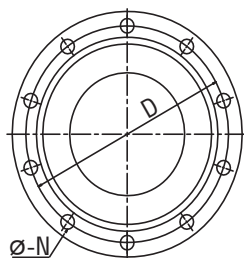
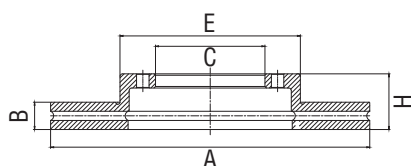

- A - Диаметр диска (мм)
- B - Толщина диска (мм)
- C - Диаметр центрирующего отверстия (мм)
- H - Высота диска (мм)
- D - Диаметр окружности расположения крепежных отверстий (мм)
- N - Количество крепежных отверстий
- E - Диаметр ступицы
- Q - Размер крепежного отверстия

410201

SKODA

SKODA FABIA, OCTAVIA,
ROOMSTER

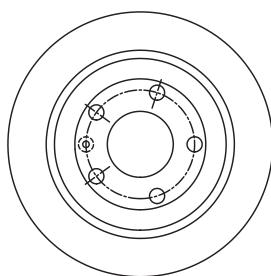

PC

A	B	C	H	D	E	N	Ø
256	22	65	36,5	100	146	5+1	15,8

O.E.M.

1J0615301D/1J0615301L/
6R0615301/8Z0615301B/
8Z0615301D/1J0615301

Поз.



410208

SKODA

SKODA OCTAVIA

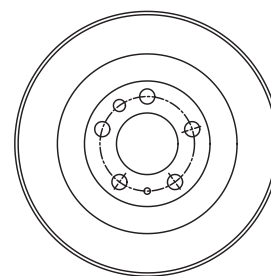

PC

A	B	C	H	D	E	N	Ø
279,8	22	65	36,6	100	145	5+1+1	16,1

O.E.M.

1J0615301E/1J0615301M

Поз.



410215

SKODA

SKODA OCTAVIA, YETI

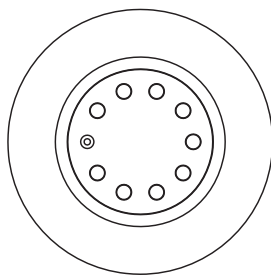

LCV

A	B	C	H	D	E	N	Ø
280	22	65	49,5	112	154,2	9+1	15,3

O.E.M.

1K0615301S/1K0615301AC

Поз.



410228

SKODA

SKODA OCTAVIA, SUPERB

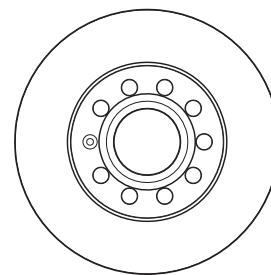

LCV

A	B	C	H	D	E	N	Ø
260	12	65	48	112	150,1	9+1	15,3

O.E.M.

1K0615601L

Поз.



410237

SKODA

SKODA FABIA, OCTAVIA,
ROOMSTER

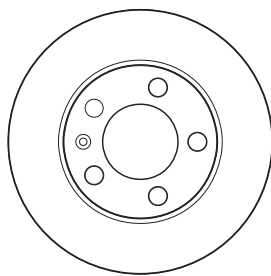

PC

A	B	C	H	D	E	N	Ø
232	9	65	39	100	135	5+1	15,8

O.E.M.

1J0615601

Поз.



410243

SKODA

SKODA SUPERB (3U) 02-08

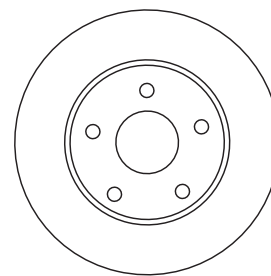

PC

A	B	C	H	D	E	N	Ø
244,8	10	68,2	63,7	112	145,6	5	15,5

O.E.M.

4A0615601A

Поз.



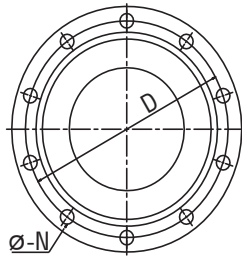
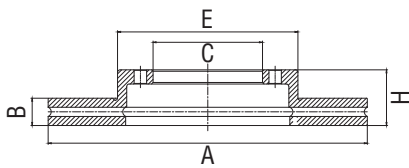

A - Диаметр диска (мм)
 B - Толщина диска (мм)
 C - Диаметр центрирующего отверстия (мм)
 H - Высота диска (мм)
 D - Диаметр окружности расположения крепежных отверстий (мм)
 N - Количество крепежных отверстий
 E - Диаметр ступицы
 Q - Размер крепежного отверстия

020215

VOLVO

VOLVO C30,C70,S40 II 05->

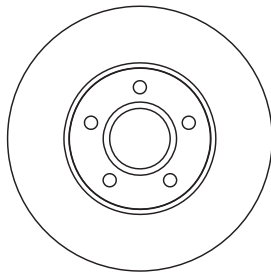

PC

A	B	C	H	D	E	N	Ø
278	25	63,6	48,5	107,95	148,3	5	13,75

O.E.M.

1223665/31262718

Поз.



020219

VOLVO

VOLVO C30,C70,S40 II 05->

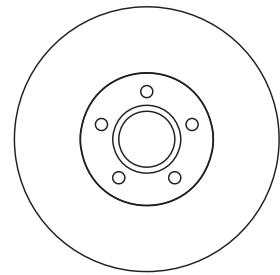

PC

A	B	C	H	D	E	N	Ø
300	25	63,55	48,5	107,95	150,2	5	13,75

O.E.M.

1323560/31262719

Поз.



020228

VOLVO

VOLVO C30,C70,S40 II 05->

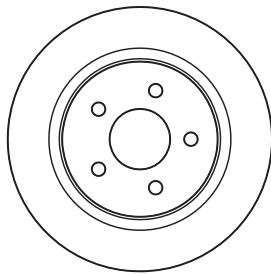

PC

A	B	C	H	D	E	N	Ø
280	11	63,5	40,7	107,95	165	5	13,75

O.E.M.

1223566/30769113

Поз.



440218

VOLVO

VOLVO C30,C70,S40 II 05->

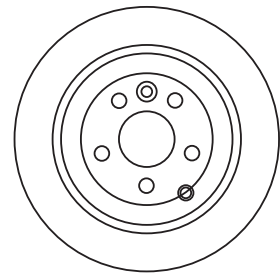

PC

A	B	C	H	D	E	N	Ø
300	28	63,7	52,1	108	150	5+1	15,6

O.E.M.

1379965/LR000571

Поз.



030254

VOLKSWAGEN

VW LT 95-06

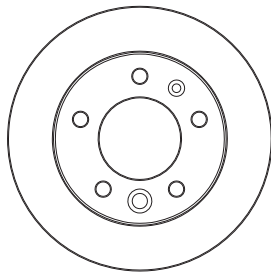

LCV

A	B	C	H	D	E	N	Ø
276	22	85	77	130	180,4	5	15

O.E.M.

9024210712/9014210312

Поз.



030243

VOLKSWAGEN

VW LT 28-46 95-06

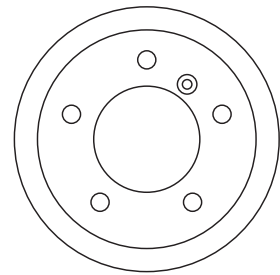

LCV

A	B	C	H	D	E	N	Ø
258,5	12	85,04	96,7	130	180,5	5+1	15,1

O.E.M.

9014230612

Поз.



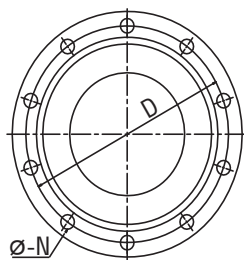
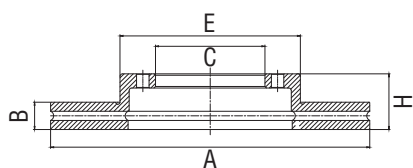

- A - Диаметр диска (мм)
- B - Толщина диска (мм)
- C - Диаметр центрирующего отверстия (мм)
- H - Высота диска (мм)
- D - Диаметр окружности расположения крепежных отверстий (мм)
- N - Количество крепежных отверстий
- E - Диаметр ступицы
- Q - Размер крепежного отверстия

030216

VOLKSWAGEN

LCV

VW CRAFTER 06->

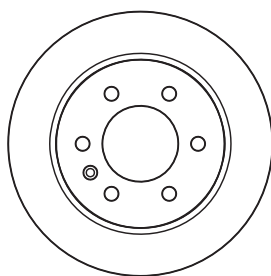

A	B	C	H	D	E	N	Ø
298	16,3	85	71,4	130	190	6+1	15,3

O.E.M.

9064230012

Поз.



030211

VOLKSWAGEN

LCV

VW CRAFTER 06->

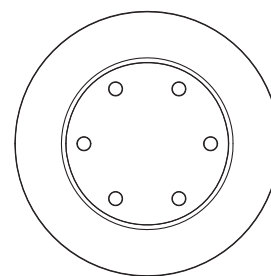

A	B	C	H	D	E	N	Ø
303	28	120	93	145	86	6	15,1

O.E.M.

9064230112/2E0615601

Поз.



030207

VOLKSWAGEN

LCV

VW LT 28-46 95-06

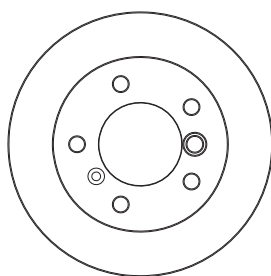

A	B	C	H	D	E	N	Ø
272,8	16	85	96,75	130	180,4	5+1+1	15,3

O.E.M.

9024230112/2D0615601A

Поз.



030206

VOLKSWAGEN

LCV

VW LT 28-46 95-06

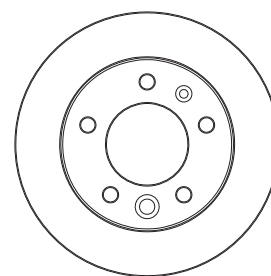

A	B	C	H	D	E	N	Ø
276	22	85	77	130	174	5+1+1	15,3

O.E.M.

9014210312/9024210312

Поз.



030205

VOLKSWAGEN

LCV

VW CRAFTER 06->

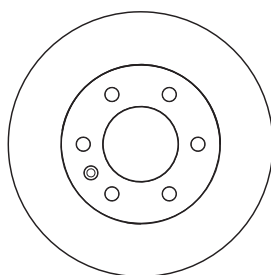

A	B	C	H	D	E	N	Ø
300	28	85	68,5	130	180,4	6+1	15,3

O.E.M.

9064210012 / 2E0615301

Поз.



320222

VOLKSWAGEN

PC

VW PASSAT B5 97-05

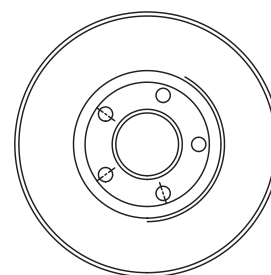

A	B	C	H	D	E	N	Ø
287,8	24,8	68,2	46,3	112	148,1	5	15,5

O.E.M.

8E0615301Q

Поз.



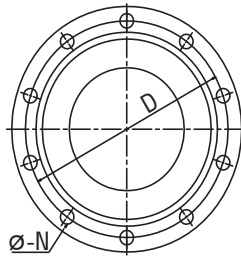
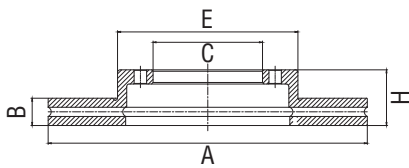

- A - Диаметр диска (мм)
- B - Толщина диска (мм)
- C - Диаметр центрирующего отверстия (мм)
- H - Высота диска (мм)
- D - Диаметр окружности расположения крепежных отверстий (мм)
- N - Количество крепежных отверстий
- E - Диаметр ступицы
- Q - Размер крепежного отверстия

320223

VOLKSWAGEN

VW PASSAT B5, PHAETON

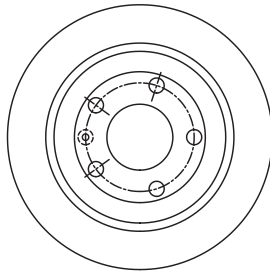

PC

A	B	C	H	D	E	N	Ø
279,8	22	68,04	46,4	112	145,8	5+1	15,6

O.E.M.

8E0615301D

Поз.



410201

VOLKSWAGEN

BORA, FOX, GOLF4, POLO

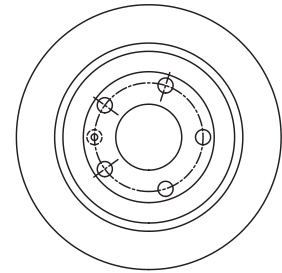

PC

A	B	C	H	D	E	N	Ø
256	22	65	36,5	100	146	5+1	15,8

O.E.M.

1J0615301D/1J0615301L/
6R0615301/8Z0615301B/
8Z0615301D/1J0615301

Поз.



410205

VOLKSWAGEN

VW TRANSPORTER IV ->03

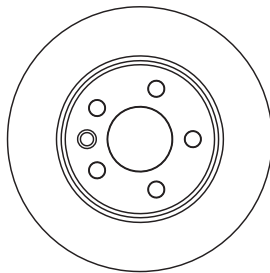

LCV

A	B	C	H	D	E	N	Ø
280	11,95	68,15	40,35	112	158,85	5+1	16,6

O.E.M.

701615601/701615601A

Поз.



410208

VOLKSWAGEN

VW GOLF IV, BORA

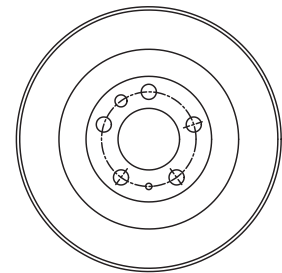

PC

A	B	C	H	D	E	N	Ø
279,8	22	65	36,6	100	145	5+1+1	16,1

O.E.M.

1J0615301E/1J0615301M

Поз.



410213

VOLKSWAGEN

VW TRANSPORTER T4 ->03

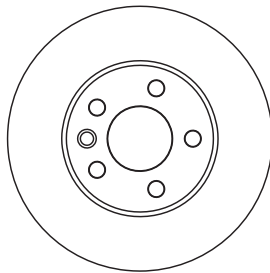

LCV

A	B	C	H	D	E	N	Ø
280	24,05	68,15	55,25	112	155,45	5+1	16,65

O.E.M.

7D0615301C/701615301F

Поз.



410215

VOLKSWAGEN

VW CADDY, GOLF IV, BORA

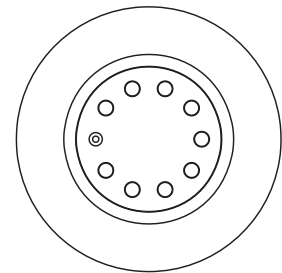

LCV

A	B	C	H	D	E	N	Ø
280	22	65	49,5	112	154,2	9+1	15,3

O.E.M.

1K0615301S/1K0615301AC

Поз.



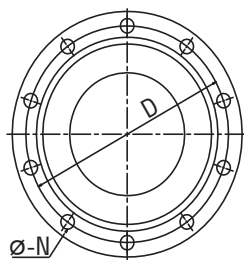
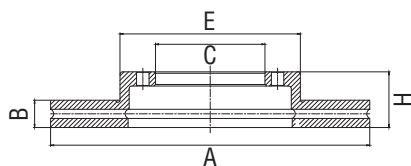

- A - Диаметр диска (мм)
- B - Толщина диска (мм)
- C - Диаметр центрирующего отверстия (мм)
- H - Высота диска (мм)
- D - Диаметр окружности расположения крепежных отверстий (мм)
- N - Количество крепежных отверстий
- E - Диаметр ступицы
- Q - Размер крепежного отверстия

410228

VOLKSWAGEN

VW CADDY, GOLF V, VI

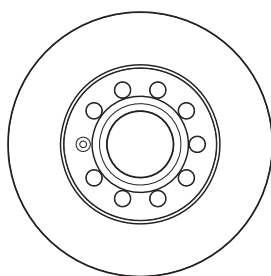

LCV

A	B	C	H	D	E	N	Ø
260	12	65	48	112	150,1	9+1	15,3

O.E.M.

1K0615601L

Поз.



410237

VOLKSWAGEN

VW GOLF IV, BORA

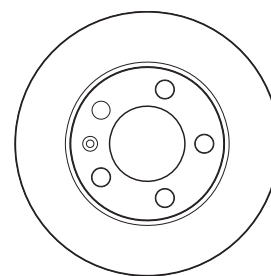

PC

A	B	C	H	D	E	N	Ø
232	9	65	39	100	135	5+1	15,8

O.E.M.

1J0615601

Поз.



410243

VOLKSWAGEN

VW PASSAT B5

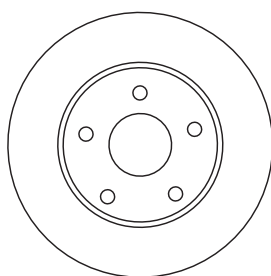

PC

A	B	C	H	D	E	N	Ø
244,8	10	68,2	63,7	112	145,6	5	15,5

O.E.M.

4A0615601A

Поз.



410254

VOLKSWAGEN

VW TRANSPORTER T5 03-

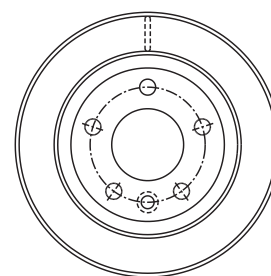

LCV

A	B	C	H	D	E	N	Ø
293,8	22	76	44,4	120	167	5,1	16,6

O.E.M.

7H0615601B

Поз.



ASP MENSAN



Maysan Mando

MNS

MNS

MNS

УКТООТӨДӨМӨН УЕНТӨ
8 (800) 555-21-12
СЕРВИС ЗАПАЧНЫХ МАШИН
РЕМОНТ ШИННИ МАШИНА





телефон сервисной службы:
8-800-333-0-911
звонок бесплатный из любого региона России

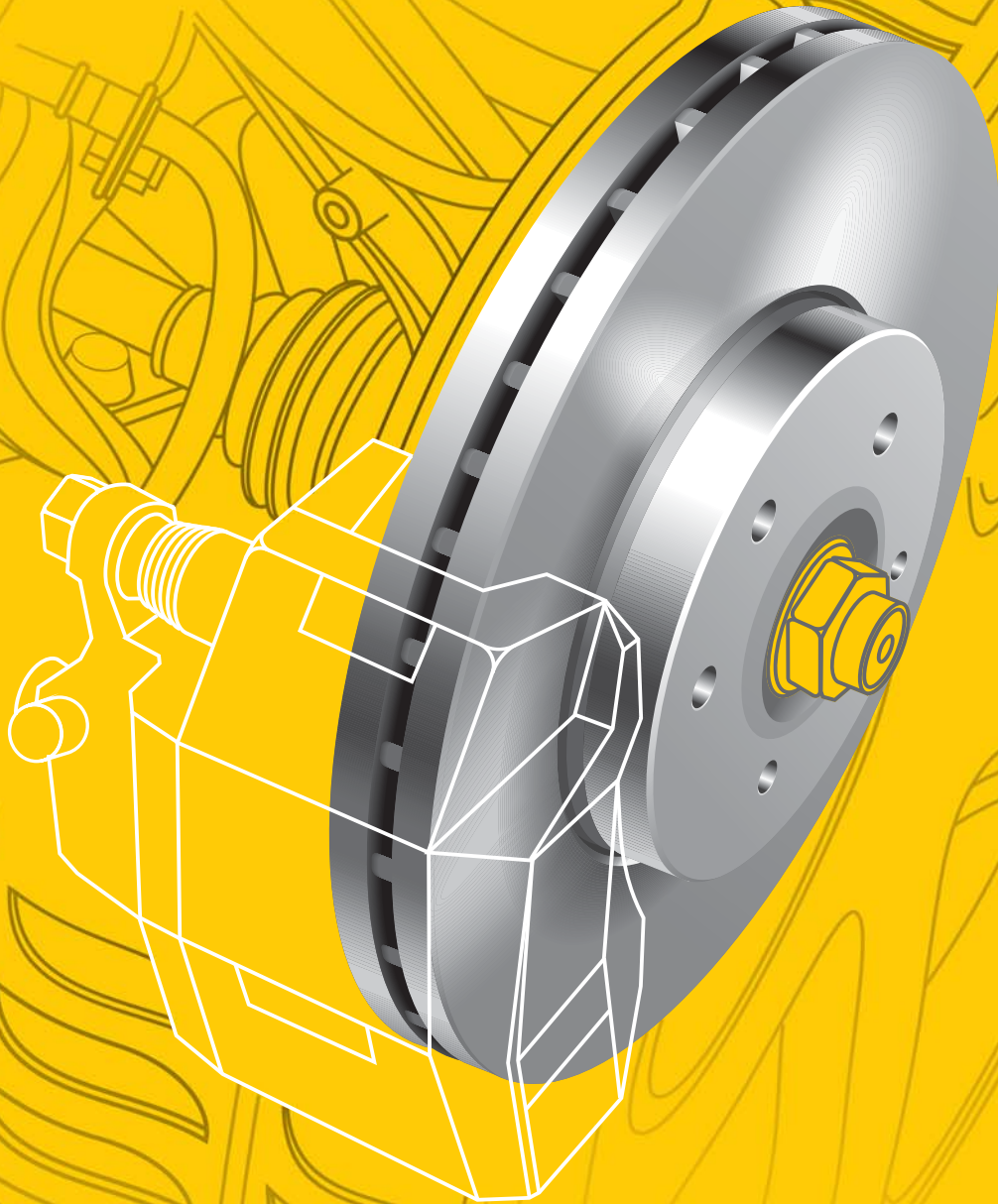

ЗАО «Р и А Партнер Консалтинг» является официальным дистрибьютором и эксклюзивным поставщиком продукции торговой марки «ASP MENSAN» на территорию России и стран Таможенного Союза

www.aspmensan.ru ■ www.rapaco.ru